

Strike plate template
Right
SLC 50

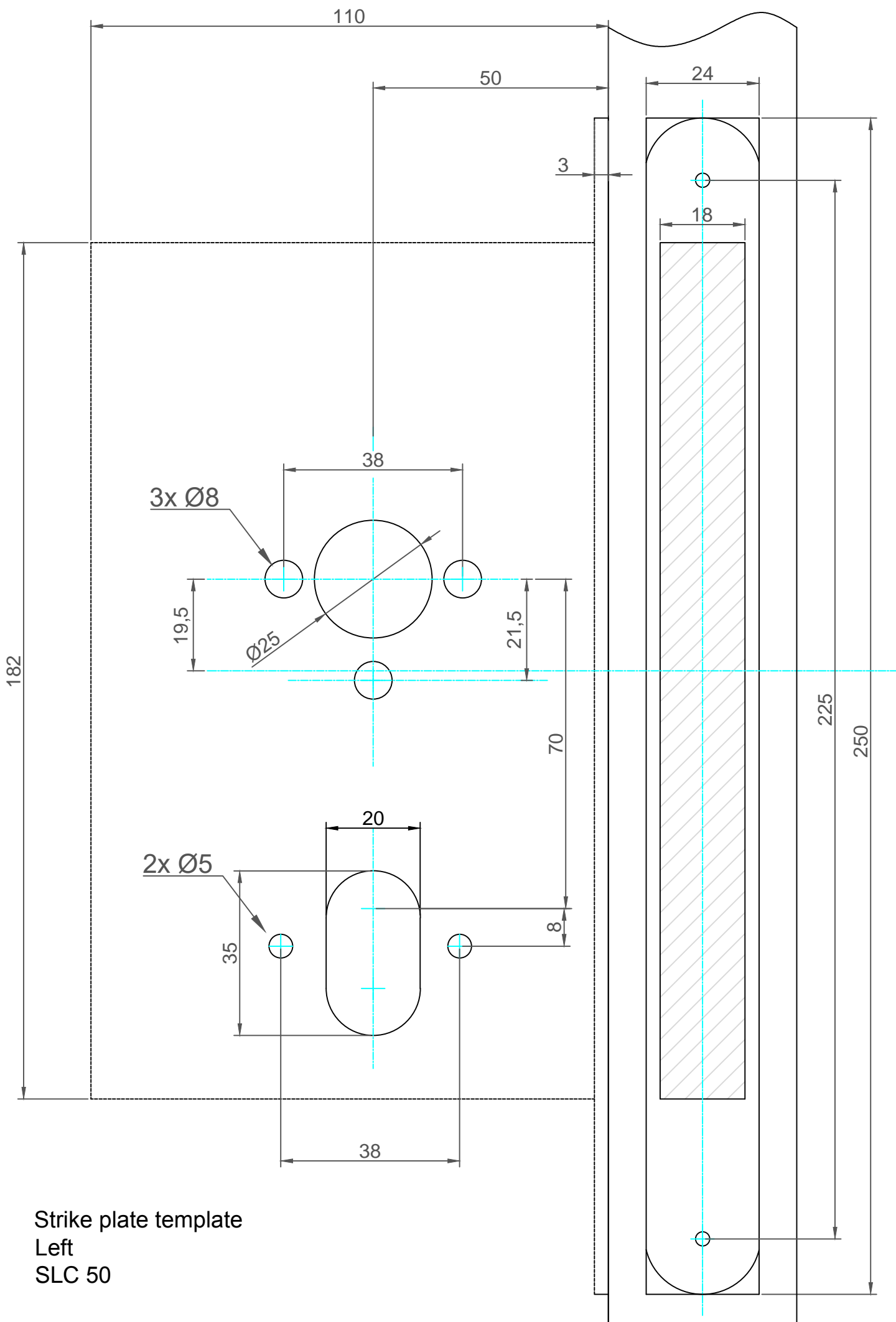

Strike plate template
 Left
 SLC 50